



HAL
open science

Techno-enviro-economic analysis of second-generation bioethanol at plant-scale by different pre-treatments of biomass from palm oil waste

Hasbi Priadi, Sary Awad, Audrey Villot, Yves Andres, Widodo Wahyu Purwanto

► To cite this version:

Hasbi Priadi, Sary Awad, Audrey Villot, Yves Andres, Widodo Wahyu Purwanto. Techno-enviro-economic analysis of second-generation bioethanol at plant-scale by different pre-treatments of biomass from palm oil waste. *Energy Conversion and Management: X*, 2024, 21, 10.1016/j.ecmx.2023.100522 . hal-04590784

HAL Id: hal-04590784

<https://nantes-universite.hal.science/hal-04590784>

Submitted on 28 May 2024

HAL is a multi-disciplinary open access archive for the deposit and dissemination of scientific research documents, whether they are published or not. The documents may come from teaching and research institutions in France or abroad, or from public or private research centers.

L'archive ouverte pluridisciplinaire **HAL**, est destinée au dépôt et à la diffusion de documents scientifiques de niveau recherche, publiés ou non, émanant des établissements d'enseignement et de recherche français ou étrangers, des laboratoires publics ou privés.



Distributed under a Creative Commons Attribution - NonCommercial - NoDerivatives 4.0 International License



Techno-enviro-economic analysis of second-generation bioethanol at plant-scale by different pre-treatments of biomass from palm oil waste

Hasbi Priadi^{a,b,c}, Sary Awad^c, Audrey Villot^c, Yves Andres^{c,*}, Widodo Wahyu Purwanto^{a,b,*}

^a Sustainable Energy Systems and Policy Research Cluster, Universitas Indonesia, Depok 16424, Indonesia

^b Department of Chemical Engineering, Faculty of Engineering, Universitas Indonesia, Depok 16424, Indonesia

^c IMT-Atlantique, GEPEA UMR-CNRS 6144, Nantes 44300, France

ARTICLE INFO

Keywords:

Catalytic hydrothermal hydrolysis
Palm tree frond
Second-generation bioethanol
Simulation
Techno-enviro-economic assessment
Thermochemical conversion

ABSTRACT

This study evaluates three pathways: supercritical water treatment (SCW), CO₂-water (scCO₂-H₂O), and catalytic hydrothermal hydrolysis (CHH) to produce second-generation bioethanol using palm tree fronds (PTF) as feedstock. The analysis focuses on technical performances using process simulation with Aspen Plus™, environmental evaluation by applying a Life Cycle Assessment (LCA) framework and an economic analysis using the levelized cost. The results of the technical performances reveal CHH as the best pathway for bioethanol production, with the highest ethanol yield at 273 L/tonne dry PTF and a substantial NER of 2.2, outperforming SCW and scCO₂-H₂O. From an environmental evaluation, CHH reveals lower carbon footprints of 61 g CO₂ per MJ. Economically, CHH is competitive, with an ethanol production cost of 1.11 \$/L, comparable to the enzymatic hydrolysis process. These findings provide the technical, environmental, and economic aspects of a promising route for lignocellulosic bioethanol production while suggesting pathways for further optimisation for future research.

Introduction

Currently, the potential global biomass supply is 53 EJ. It is predicted to rise threefold to 153 EJ in 2050, accounting for 25 % of the global primary energy supply [15]. Indonesia is one of the countries with potential biomass production from palm oil plantations and is the largest palm oil producer in the world. Data from [18] also supports the idea that agricultural residues from palm oil plantations, consisting of empty fruit bunches (EFB), palm tree fronds (PTF), palm tree trunk (PTT), palm kernel shell (PKS), and palm oil mill effluent (POME), are potential bioenergy materials for implementing a sustainable system in the palm

oil industry [35]. The Indonesian government has undertaken efforts through the Ministry of Agriculture to create a sustainable palm oil system through the Indonesian Sustainable Palm Oil (ISPO) program, which must be implemented by all palm oil planting regions throughout Indonesia. The program implements sustainable business development, environmental management, and monitoring. Fatty acid methyl esters (FAME) from palm oil are used as raw materials in the production of biodiesel in the transportation sector and have successfully become a biofuel application in Indonesia. The success of Indonesia's biodiesel production has become one of Indonesia's references for other biofuels, such as second-generation bioethanol production using biomass from

Abbreviations: EJ, Exajoules; MJ, Megajoules; CHH, Catalytic hydrothermal hydrolysis; EFB, Empty fruit bunch; EtOH, Ethanol; PTF, Palm tree frond; PTT, Palm tree trunk; PKS, Palm kernel shell; ISPO, Indonesian sustainable palm oil; FAME, Fatty acid methyl esters; POME, Palm oil mill effluents; CPO, Crude palm oil; NRTL, Non-random two liquids; LHW, Liquid hot water; CSTR, Continuous stirred-tank reactor; PFR, Plug flow reactor; SCW, Supercritical Water; scCO₂-H₂O, Supercritical CO₂-Water; k, Rate constant; A, Pre-exponential factor; E_a, Energy activation; R, Universal gas constant; T, Absolute temperature (K); r_m, Rate of reaction; k_m, Rate constant specific substance; C_m, Concentration specific substance; M, Specific substance; CO₂, Carbon dioxide; L, Litres; kL, Kilo litres; IEA, International Energy Agency; AFEX, Ammonia fibre explosion; C6, Glucose; C5, Xylose; H₂O, Water; pH, Potential of Hydrogen; HCl, Chloric Acid; H₂SO₄, Sulfuric Acid; H, hour; 5-HMF, 5-Hydroxymethylfurfural; wt%, Weight percent; m_{EtOH}, Mass rate Ethanol (kg/h); EtOH, Ethanol*; LHV, Low heating value; Q, Heat (MJ/h); W, Work (MJ/h); S/L, Solid/Liquid Ratio; LCA, Life cycle assessment; ISCC, International Sustainability and Carbon Certification; CO_{2eq}, Carbon dioxide equivalent; Kwh_{el}, Kilowatt hour electricity; CH₄, Methane; GWP, Global Warming Potential; LCOP, Levelised cost of product; CAPEX, Capital expenditure; CRF, Capital recovery factor; V.Cost, Variable cost; F.O&M, Fixed operation and maintenance; Pr, Production of Ethanol; r, Discount rate; n, Lifetime of technologies; NER, Net Energy Ratio; %Vol, Volume percentage; CEPCI, Chemical Engineering Plant Cost Index.

* Corresponding authors.

E-mail addresses: yves.andres@imt-atlantique.fr (Y. Andres), widodo@che.ui.ac.id (W.W. Purwanto).

<https://doi.org/10.1016/j.ecmx.2023.100522>

Received 31 July 2023; Received in revised form 14 December 2023; Accepted 27 December 2023

Available online 5 January 2024

2590-1745/© 2024 The Authors. Published by Elsevier Ltd. This is an open access article under the CC BY-NC-ND license (<http://creativecommons.org/licenses/by-nc-nd/4.0/>).

the palm oil industry.

Second-generation bioethanol is a renewable and sustainable fuel with the potential to reduce carbon dioxide (CO₂) emissions worldwide. According to recent studies, second-generation bioethanol has the potential to reduce global CO₂ emissions by up to 90 % compared with fossil fuels [12]. The use of lignocellulosic biomass to produce bioethanol has been applied in various countries in Europe, the United States, and Brazil, from the laboratory scale to a larger scale, mainly in the transportation sector [13,14]. Developing second-generation bioethanol plants on an industrial scale is critical for their widespread use as a sustainable fuel source. Scaling up bioethanol production requires the overcoming of technological and economic barriers to make the production process commercially viable [2].

The adoption of second-generation bioethanol in Europe, the United States, and Brazil has brought significant economic benefits. With the increasing demand for biofuels, second-generation bioethanol production has created new employment opportunities and increased revenue for the agricultural and forestry sectors. In addition, second-generation bioethanol production has helped reduce dependence on imported fossil fuels, leading to improved energy security and independence [13]. The use of second-generation bioethanol in Europe could generate up to €15 billion in additional revenue and create over 300,000 new jobs by 2030 [6].

Second-generation bioethanol production presents unique challenges that must be addressed to achieve successful commercial-scale production. Indonesia's current bioethanol production is dominated by first-generation bioethanol using molasses as a feedstock, which creates competition between molasses as a food ingredient and bioethanol production. Using molasses causes ethanol prices to rise higher than gasoline prices, making blending ethanol as vehicle fuel challenging. [1].

Several studies have focused on plant-scale second-generation bioethanol production using techno-economic analyses. Quintero et al. [36] conducted plant-scale bioethanol production with different biomasses using diluted acid, liquid hot water (LHW), and ammonia fibre explosion (AFEX) as pretreatments before enzymatic hydrolysis for cellulose degradation. Similarly, the evaluation of plant-scale bioethanol with sugarcane, corn stover, and rice straw as feedstock using the enzymatic hydrolysis process for the degradation of lignocellulosic biomass [26,32,50] evaluated the effect of different process parameters on the economic feasibility of the plant, including feedstock costs, pretreatment conditions, and fermentation parameters. However, no simulation study has been conducted on the degradation of cellulosic material using thermochemical conversion. Although these studies provide valuable insights into the techno-economic feasibility of second-generation bioethanol production, a research gap exists in the entire production chain, from hydrolysis to product recovery, at the industrial scale, using thermochemical conversion to degrade cellulose. Degradation of cellulose using thermochemical has been previously discussed [4,5,39] using supercritical water and supercritical CO₂ mixed in water. Catalysts can also degrade cellulose into glucose (C6) sugars [23,25,48].

The objective of this study was to provide an extensive analysis encompassing technology, the environment, and economics concerning the production of second-generation bioethanol through various cellulose hydrolysis methods employing thermochemical processes. This analysis primarily concentrates on the industrial-scale technical performance, considering economic and environmental aspects to determine the most viable pathway.

Methodology

Process description

This study presents a process simulation for bioethanol production from palm tree frond (PTF) biomass. The PTF was collected from a palm oil plantation in the Riau Province of Indonesia. As Indonesia's most

significant producer of crude palm oil (CPO), the Riau Province was selected as the location for plantations because of its prominence in this industry. Moreover, PTF represents a potential biomass source based on its biochemical composition and availability [35]. The biomass was milled into smaller 5–10 mm particles to reduce crystallinity before hydrolysis. Hemicellulose degradation for xylose (C5) production utilises liquid hot water (LHW) hydrolysis. Additionally, three scenarios have been proposed for cellulose degradation: supercritical water (SCW) hydrolysis, carbon dioxide-water mixtures (scCO₂-H₂O), and catalysts hydrothermal hydrolysis (CHH). The fermentation process is carried out by employing two types of microorganisms, one for C5 and one for C6 sugars, to minimise furfural production from hemicellulose during C6 fermentation. The ethanol obtained from fermentation has a high-water content, which must be separated using two distillation columns. After distillation, pressure swing adsorption was implemented to purify the ethanol to 99.5 %. An overview of the entire process flow diagram is provided in Fig. 1.

The bioethanol production capacity in this study is set at 50,000 kL per annum. This capacity was selected based on existing commercial lignocellulosic ethanol facilities in the United States, Brazil, Italy, France, and India. Moreover, the by-product lignin is utilised as an energy source to fulfil the utility requirements for the bioethanol production process. The hydrolysis of cellulose via three distinct pathways for bioethanol production will be assessed from technical performance, environmental and economic standpoints to assess the carbon footprint and production costs of bioethanol production, respectively.

Process simulation

Simulations of plant-scale second-generation bioethanol production using Aspen Plus™ were conducted by incorporating the biocomponents of biomass, including hemicellulose, cellulose, and lignin by entering physical property data and the thermophysical property model obtained from Gorensek et al. [8]. The non-random two-liquid (NRTL) thermodynamic model was used to calculate the activity coefficients of the liquid phase and the Henry component for the solubility of gases inside the liquid. PTF was chosen as the potential feedstock because of its availability and biocomponents. Composition of PTF obtained from Yusof et al. [49] consist of hemicellulose 24 %, cellulose 35 %, lignin 17 %, ash 4 % and extractive 17 %. The kinetics of hemicellulose and cellulose degradation utilised first-order kinetics to model PTF into sugars, as described by Eq. (1) and Eq. (2).

$$k_m = A e^{-\frac{E_a}{RT}} \quad (1)$$

$$-r_m = k_m C_m \quad (2)$$

In this rate expression, k_m represents the rate constant for each substance, A is the pre-exponential factor, and E_a is energy activation, T is temperature and R is gas constant. The value of k_m used for reaction rate, represent as $-r_m$ that depends on concentration (C_m) for particular substance (m) in the degradation of cellulose and hemicellulose. This kinetic approach was selected based on experimental data to effectively predict the yield and conversion of sugars from the hydrolysis of lignocellulosic biomass using liquid hot water (LHW), supercritical water, and CO₂-water. The results of the kinetic and reactor model were input into simulations as subroutines in each hydrolysis reactor to determine the effect of process conditions on the hydrolysis rate of hemicellulose and cellulose, which supports the identification of optimal parameters to maximise sugar yields essential for bioethanol production. The sequence of the simulation process is illustrated in Fig. 2.

The first step in the bioethanol production simulation with PTF starts with the pretreatment process. The objective of the pretreatment process is to produce C5 sugar from hemicellulose. LHW uses only water as a reagent with higher yield of hemicellulose-derived sugar, higher cellulase hydrolysis rate, and lower degradation products compared to other

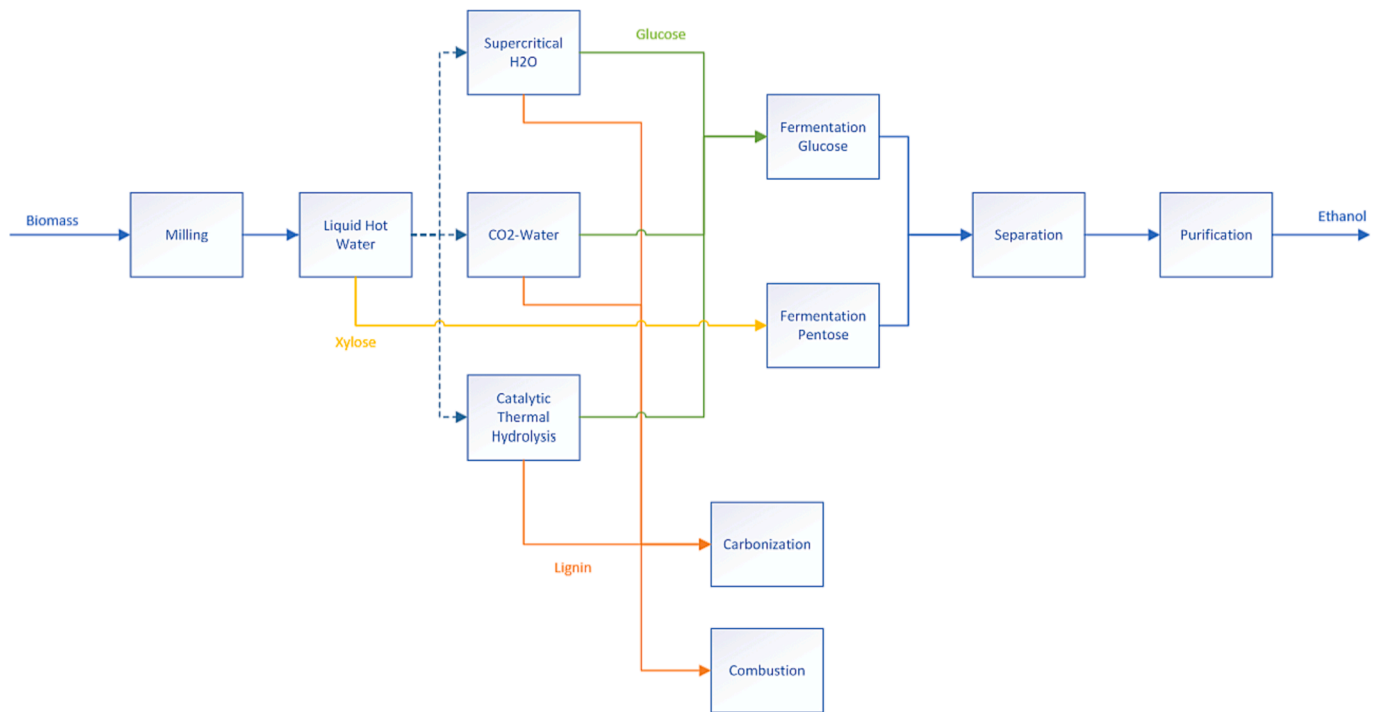

Fig. 1. Block Flow Diagram of the process.

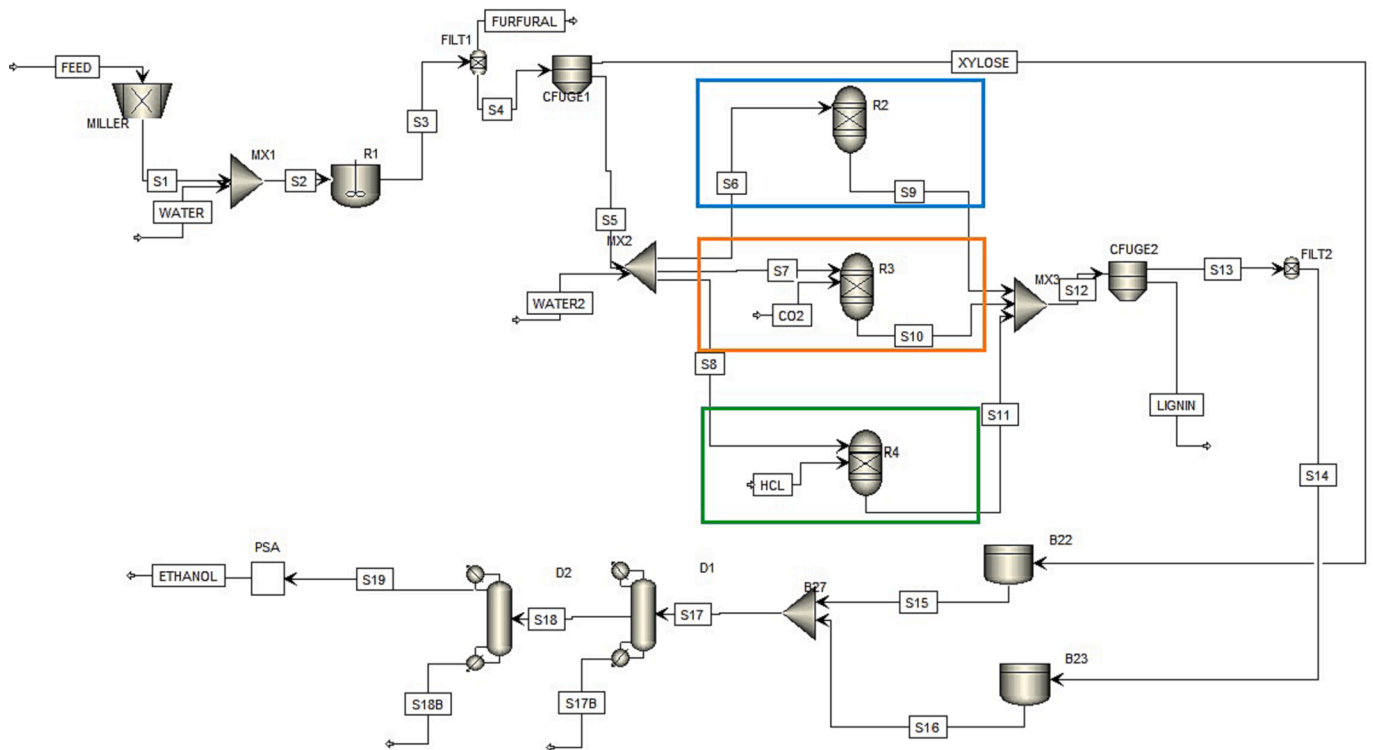

Fig. 2. Process flow diagram for simulation lignocellulosic bioethanol with PTF. Blue block: supercritical water hydrolysis. Orange block: CO₂-water hydrolysis. Green block: Catalytic hydrothermal hydrolysis. (For interpretation of the references to colour in this figure legend, the reader is referred to the web version of this article.)

pretreatment methods [21,42]. The LHW process using continuous stirred tank reactor (CSTR) modelled with RYield using subroutines in Aspen Plus including the kinetic data from Yusof et al. [49]. The selection of the kinetic data is based on experimental evidence using the same raw material, specifically PTF that has a higher reducing sugar

production by 55.6 % compared to Quintero et al. (2008) with 40.8 % using rice straw as a feedstock. Based on kinetic data the optimal LHW operating conditions is at 190 °C with solid/liquid (S/L) ratio of 1:10 to maximize the production of xylose and oligomers. Hydrolysate from LWH process then treated to separate the liquid and solid phase, where

liquid hydrolysate is rich of xylose.

In the second step, the cellulose is broken down using SCW, scCO₂-H₂O, and CHH using solid hydrolysate from the LHW process. SCW is a promising medium for converting biomass into value-added products. The hydrolysis using supercritical water occurred at 380 °C and 220 bar. The solid/liquid ratio was 1/10, and the reaction kinetics were modelled using a first-order reaction model. Under these conditions, cellulose rapidly decomposes into oligomers, monomers and degradation products [52]. Supercritical water processes using plug flow reactor (PFR) modelled with RYield inside Aspen Plus. The kinetic equations for supercritical water hydrolysis taken from Zhao et al. [51] were incorporated into the model reactor via a user subroutine. This kinetics were chosen because they demonstrate high cellulose-to-glucose conversion of up to 33 % and provide detailed product composition data for the hydrolysate.

Other than SCW, the high pressure of CO₂-water has already been demonstrated to be selective for the dissolution of hemicellulose. The presence of water increases the sugar yield and the effectiveness of pretreatment [7]. Furthermore, the synergetic attack of CO₂ and H₂O enables fibre separation, exposing the surface, and leading to high enzymatic digestibility of the processed solids [9,28,45]. Supercritical CO₂ has been investigated as a nontoxic, non-flammable, and inexpensive method that has the advantage of reducing the temperature of the hydrolysis process, affecting the minor generation of degradation products, and producing higher yields of sugar. Recently, the use of supercritical CO₂-water in biomass pretreatment resulted in an acidic mixture because of *in situ* [34,40] and two-step dissociation of carbonic acid according to the following equation:



The reaction mixture Eqs. (3) and (4) is also less corrosive, and the medium's acidity does not require acid neutralisation because CO₂ is removed from the solution during depressurisation, thereby increasing the pH of the reaction mixture [28]. Thus, it can be concluded that despite active research to develop more sustainable biomass technologies, introducing Supercritical CO₂ (scCO₂-H₂O) as an acid catalyst promoter is a more eco-friendly and economically favourable strategy [22]. A PFR model was constructed in Aspen Plus using RYield to simulate scCO₂-H₂O hydrolysis. The kinetic parameters for the CO₂-water system were taken from Brunner [4] and incorporated into the reactor model via subroutine. The kinetics from Brunner were selected specifically for their application to cellulose depolymerisation into oligomers and glucose.

The utilisation of heterogeneous catalysts for biomass valorisation is essential due to their efficacy, thermal stability, and adaptable physicochemical characteristics. The categories of catalysts conventionally employed for lignocellulosic biomass conversion frequently entail impregnating the cellulosic feedstock with catalytic acids such as hydrochloric acid (HCl) or sulphuric acid (H₂SO₄). These inorganic acids promote the hydrolysis of glycosidic bonds in cellulose and hemicellulose polymers to release fermentable sugars. Additionally, acid catalysts augment reaction kinetics and reduce required severity factors relative to non-catalytic processes. Hence, acid-catalysed hydrolysis offers numerous advantages for biomass conversion to value-added products. Recently, studies on heterogeneous catalysts for biomass valorisation has been conducted by Wang et al. [48] regarding the catalytic applications of nanoporous materials in biomass. The soluble cellulose was easily hydrolysed into glucose at a temperature of 130 °C for one hour with the support of mechanical pretreatment. Kobayashi et al. [23] reported using impregnated activated carbon (AC) with a trace of 0.0012 % HCl to hydrolyse the cellulose into glucose with a sugar yield of 88 % at 180 °C for 20 min. This method resulted in better physical contact between cellulose and activated carbon. Unlike the other two hydrolysis

methods that kinetic data are available, the CHH uses a CSTR modelled with RYields in Aspen Plus, the overall yield of cellulose degradation introduced into reactor model via a subroutine. The yield of glucose using CHH is based on experimental data from Kobayashi et al. [23] who reported the highest cellulose-to-sugar conversion using this technology compared to another heterogenous catalyst.

For the fermentation process, C5 and C6 sugars from the hydrothermal process were converted into ethanol using *P.stipitis* and *S.cerevisiae*, respectively, at 32 °C for 48 h of reaction time by considering the amount of inhibitor that occurred inside the hydrothermal method. The fermentation process was simulated in a batch reactor using subroutines and incorporated kinetics to determine the impact of the by-products, for continuous system the reaction running in eight reactors in parallel to maintain the production capacity of bioethanol. Kinetic equations for xylose and glucose fermentation were obtained from Bhavana Banuvalli et al. [3] and Pereira et al. [33] for xylose fermentation and glucose fermentation, respectively. Separation and purification technology was adopted from a previous National Renewable Energy Laboratory (NREL) study using distillation combined with a pressure swing adsorption membrane [11].

By-products, such as furfural, hydroxy methyl furfural (5-HMF), and organic acids, are produced during the hydrothermal process and must be treated before fermentation. Furfural and 5-hydroxymethylfurfural (5-HMF) are produced during the pretreatment of lignocellulosic biomass, can inhibit fermentation when their concentrations are high. However, studies indicate that they exhibit minimal adverse effects below a certain threshold. Given the considerable economic expenses associated with their complete removal, determining and targeting the minimum inhibitory levels may be more advantageous while pursuing a partial reduction [47]. One potential method for achieving this purification is through adsorption, employing activated carbon to selectively reduce the levels of furfural and 5-HMF in the pretreated hydrolysates [10]. However, research shows they exhibit minimal adverse effects below certain thresholds. Given the substantial costs of complete removal, targeting minimum inhibitory levels through partial reduction may be more beneficial economically [47]. One potential purification method is adsorption with activated carbon to selectively decrease furfural and 5-HMF levels in the pretreated hydrolysates [10]. This procedure was implemented to reduce the concentrations of furfural and 5-HMF, inhibitory compounds that impede subsequent fermentation.

Performance analysis

Technical analysis

A technical assessment of a second-generation bioethanol plant scale was performed with various hydrothermal technologies for cellulose pretreatment at different operating conditions such as temperatures, pressures, and reaction time, as shown in Table 1. The solid per liquid ratio (S/L) was kept at 1:10 for all hydrothermal process. The technical performances of processes expressed as yield of bioethanol and Net Energy Ratio (NER). Yield of bioethanol and NER obtained from mass and energy balance taken from process simulation. Yield defined as litres of ethanol produced per tonne of PTF. The NER of the system is expressed by Eq. (5).

Table 1
Operating conditions.

Hydrolysis Process	Temperature (°C)	Pressure (bar)	S/L Ratio	Source
LHW	190	15	1/10	[49]
SCW	380	220	1/10	[51]
scCO ₂ -H ₂ O	260	250	1/10 + 96 %vol CO ₂	[4]
CHH	180	14	1/10 + AC + 0.0012 %vol Dilute Acid	[23]

$$\eta = \frac{\sum \dot{m}_{EToH} \times LHV_{EToH}}{\sum (Q_i + W_e)} \quad (5)$$

The amount of ethanol (\dot{m}_{EToH}) with the low heating value (LHV) divided by the amount heat (Q_i) and work (W_e) as energy input determine the energy efficiency of production system. The optimum pathway for producing sugars from cellulosic materials will be determined by the highest amount of bioethanol produced and the least amount of energy consumed.

Environmental analysis

The life cycle assessment (LCA) reference methodology (ISO 14041), which includes the following frameworks: goal and scope definition, life cycle inventory, impact assessment, and interpretation, was used to evaluate the environmental impact. The inventory data included pre-production operations for the PTF considered within the stated strategy and scope. The assumptions for the scope of the LCA are: (1) direct and indirect emission; (2) cradle-to-gate system; (3) not accounting for carbon neutrality; (4) emission feedstock from seedlings to harvesting, including transportation to the plant; and (5) direct emission from Aspen Plus. The system boundaries are presented in Fig. 3. However, because of their minimal impact, part manufacturing and plant construction emissions were excluded from the LCA boundary.

The impact assessment stage attempts to convert material and energy inputs into equal environmental impacts. The impact on the environment is classified for each substance [29]. However, this study only assessed the impact of global warming potential (GWP). The GWP was derived from the International Sustainability and Carbon Certification (ISCC) Report standard, in which data for molecules other than CO₂ contained in the GHG category were first transformed into CO_{2eq} values.

PTF GHG emissions obtained from Nugroho [30], starting from palm oil tree plantations until harvesting without accounting for carbon neutrality. The emissions were only weighted for the PTF contribution by harvesting and maintenance, including the electricity for the plantation, as shown in Table 2. The amount of PTF was calculated by considering it a by-product of CPO. The emissions from the

Table 2
Emission conversion factor.

Inventory	Conversion Factor	Units	Reference
N-fertilizer	5.811	kg CO ₂ /kg N	[19]
P-Fertilizer	1.011	kg CO ₂ /kg P	[19]
K-Fertilizer	0.575	kg CO ₂ /kg K	[37]
Urea	4.6	kg CO ₂ /kg N	[19]
Kieserite	0.2	kg CO ₂ /kg Mg	[19]
Dolomite	0.13	kg CO ₂ /kg Ca	[19]
Pesticides/Herbicides	10.97	kg CO ₂ /kg a.i.	[19]
Diesel	3.14	kg CO ₂ /L diesel	[19]
Electricity	1.05	kg CO ₂ /kWh _{el}	[19]
Methane (CH ₄)	27	kg CO ₂ /kg CH ₄	[19]

transportation sector were calculated by considering the direct emissions from the type of fuel, vehicle, and distance from the plantation to the bioethanol plant. Bioethanol was the primary product used in this study. The calculation of direct emissions involves examining the Aspen Plus simulation process, encompassing the emissions arising from the by-products and the utilities that facilitate bioethanol production. As each pathway produces GHG emissions, GWP measurements should account for product allocation. Therefore, the GWP in this study was expressed as gCO_{2eq} per MJ of ethanol.

Economic analysis

The levelised cost technique was used for the economic analysis, with 2022 as the base year. Eq. (6) defines the levelised cost of processes (LCOP) consists of investment costs (CAPEX), fixed operational and maintenance expenses (F.O&M), and variable costs (V.Cost), with *i* designating each system examined. The system was separated into distinct cellulose pretreatment routes for economic analysis, where *Pr* denotes the amount of bioethanol evaluated from each system.

$$LCOP_i = \frac{CAPEX_i \times CRF + F.O\&M_i + V.Cost_i}{Pr} \quad (6)$$

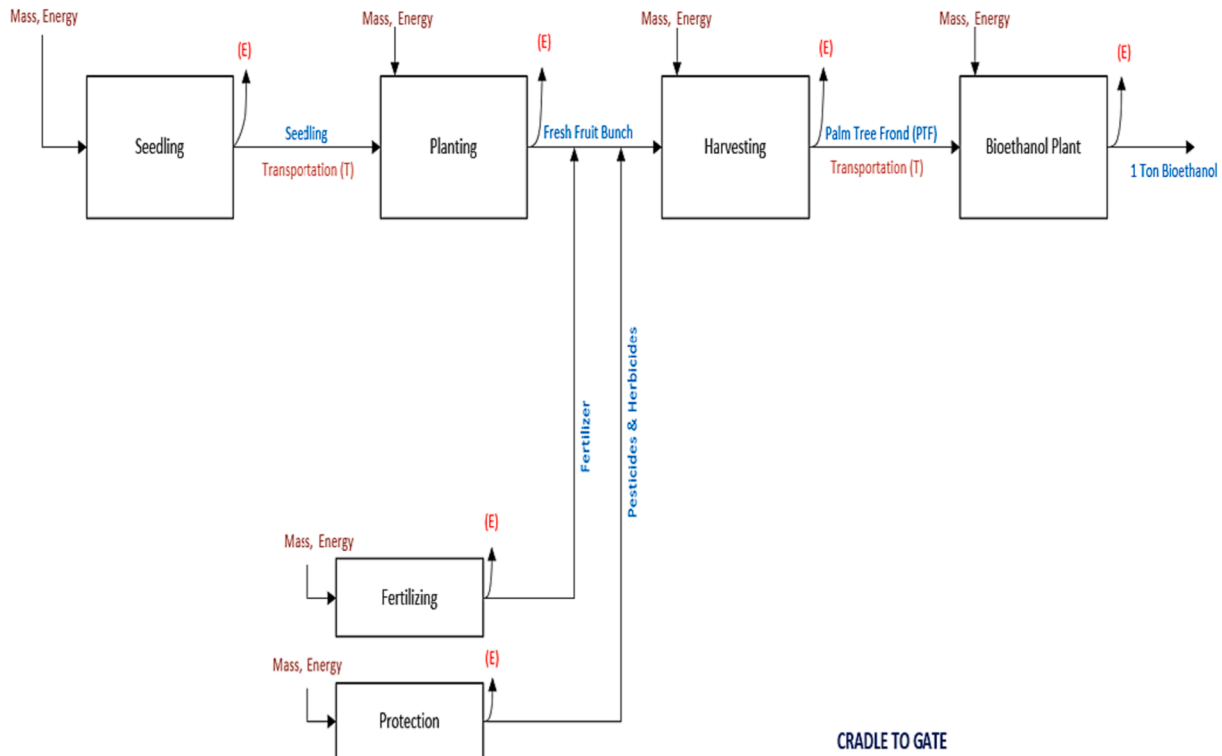

Fig. 3. The boundary of the LCA system.

$$CRF = \frac{(1+r)^n \times r}{(1+r)^n - 1} \quad (7)$$

This method does not account for inflation or the time value of money, allowing a fair comparison of the levelized cost of each technology during the timeframe of the study. The investment required for each pathway is calculated by estimating the costs associated with bare module, using the Guthrie method and CEPCI 2022 [20,43]. The CAPEX value was annualized using the capital recovery factor (CRF) described in Eq. (7), where r is the discount rate and n is the project lifetime, using 10 % and 30 years, respectively. The F.O&M estimate of 7 % of CAPEX used in this analysis is derived from published data on large-scale bioethanol production via enzymatic hydrolysis [16,17]. The V.Cost for each hydrolysis process were calculated based on the required raw materials and other supporting materials.

Results and discussion

Technical performance

Ethanol production by cellulose hydrolysis has been studied using CHH, supercritical hydrolysis, and CO₂-water hydrolysis. The results demonstrated the CHH pathway achieved the highest ethanol yields at 273 L/tonne of dry PTF, compared to 115 L/tonne and 58 L/tonne for SCW and scCO₂-H₂O. The mass balance details for the bioethanol simulation process incorporating the thermal hydrolysis methods are presented in the [Supplementary Material](#).

The low ethanol yields attained from scCO₂-H₂O cellulose conversion under the investigated conditions of 260 °C, 250 bar and 16 s resulted in degradation into oligomeric with the yield of 10 % from dry PTF versus 8 % for glucose. Moreover, at the exact operating condition, the appearance of 5-HMF with a yield of 7 % caused glucose reduction from scCO₂-H₂O hydrolysis. Reducing the residence time to 8 s minimises 5-HMF formation by 90 % while improving oligomer production. This result is similar to the research of Toscan et al. (2017), where the specified conditions are sufficient to reduce cellulose crystallinity to oligomers, they do not favour the hydrolysis of cellulose into glucose monomers, thereby inhibiting ethanol formation through fermentation. A similar case occurs for SCW, wherein the rapid reactions at 380 °C, 220 bar, and 4 s produced oligomers yielding 18 % and 19 % glucose from PTF, respectively. Other studies applying equivalent short 1–4 s reaction times to maximise sugar yields using SCW also report approximately 19 % yields from various biomass sources (Cantero et al., 2013; Sasaki et al., 1998; Yoko et al., 2022). The high ethanol yield obtained from cellulose's CHH can be attributed to the promoting effect of the activated carbon catalyst mixed with the biomass. The carbon is thought to improve the collision frequency and penetration of HCl into the cellulose structure, thereby enhancing depolymerisation [44]. Furthermore, adding activated carbon to the dilute acid suppresses the formation of by-products during ethanol production. Kobayashi et al. [23] demonstrate that hydrolysis using water diluted with HCl at 0.0012 vol% and pH 2.5 enables more selective conversion of cellulose oligomers to glucose compared to H₂SO₄.

When comparing the conversion rate achieved by the three non-enzymatic pathways to that obtained using enzymatic hydrolysis, the enzyme route exhibited the highest yield at 278 L/tonne dry corn stover [36,50]. This represents only 2 % higher than ethanol yield reached via CHH. However, the enzyme process showed more substantial gains of 13 % and 18 % in yield relative to the SCW and scCO₂-H₂O methods, respectively. Therefore, while CHH offers comparable performance, enzymatic hydrolysis remains superior in maximising cellulose conversion to fermentable sugars under the conditions examined in this study.

Concerning energy consumption analysis has been conducted using NER for SCW, scCO₂-H₂O and CHH during bioethanol production. The NER value was optimised through the heat exchanger network and the use of unconverted cellulose and lignin residues as heat sources inside

the process, as shown in Fig. 4. The solid residues of cellulose and lignin could be used as a heat source for bioethanol production by adding EFB, a material abundant in the palm oil plantation. The result shown that, CHH had the lowest energy consumption, with an NER of 2.2, indicating that the energy from the bioethanol produced was more important than the energy for its production. The activated carbon and dilute acid catalyst used in this process provide a lower temperature for cellulose hydrolysis at 180 °C and a low pressure of 15 bars, resulting in a higher bioethanol yield and low by-products. Conversely, SCW hydrolysis has substantially higher energy requirements, with a NER of 0.26, denoting that the production energy input outweighs the energy content of the produced ethanol. Attaining supercritical water necessitates severe conditions of 380 °C and 220 bar, whereas scCO₂-H₂O requires 260 °C and 250 bar for an NER of 0.63. NER values depend on the specific system, feedstocks, and utilities [29]. For these cases, the NERs of the SCW and scCO₂-H₂O hydrolysis routes are constrained by high operating conditions and insufficient ethanol conversion.

Compared to enzymatic hydrolysis, the conventional technology for lignocellulosic ethanol production with a NER of 2.51 [29], similar with CHH differing by only 11 % with NER 2.2. In contrast, the NER values for scCO₂-H₂O and SCW processes were far higher at 75 % and 89 %, respectively. The slight NER difference between CHH and enzymatic hydrolysis is due to enzymatic hydrolysis's lower operating condition. Whereas the high operating conditions of scCO₂-H₂O and SCW, exceeding those of enzymatic and CHH, account for their substantially greater energy demands as reflected by the much higher NER values.

Environmental analysis

The environmental aspects of bioethanol production were assessed from cradle to gate, with the endpoint being ethanol derived from palm tree fronds. The primary sources of emissions from the seedling and plantation sectors are utilities such as fertilisers, pesticides, and herbicides, with synthetic fertilisers containing N, P, and K being commonly used. Herbicides and pesticides, although sparingly used, also contribute to emissions when pests and weeds appear.

The carbon footprint results from the plantations of palm oil trees are summarised in Table 3., which incorporates calculations based on reference materials. Notably, palm tree frond (PTF) recuperation is only accounted for through maintenance and harvesting, excluding the milling process used solely for crude palm oil production. The carbon footprint on transportation sector is calculated considering that trucks have a capacity of 9 tonnes and consume 0.25 km/L of diesel when loaded, while empty trucks consume 0.49 km/L [19]. The distance between the seedling area to the plantation and the plantation to the bioethanol plant were 10 km and 30 km, respectively.

In the plantation, the non-direct emissions associated with PTF production were 30 gCO₂/MJ ethanol. Emissions resulting from bioethanol production, primarily from direct emissions such as the by-products of the fermentation process and the associated utilities, were obtained through simulation processes. Among the different hydrolysis pathways, CHH exhibits the lowest carbon footprint at 61 g CO₂/MJ ethanol compared to SCW and scCO₂-H₂O with 168 g CO₂/MJ ethanol and 98 g CO₂/MJ ethanol, respectively. The heating and fermentation processes emit CO₂, which can be reused in the reactor as supercritical CO₂, adding value to the scCO₂-H₂O hydrolysis pathway, thus making the carbon footprint lower than SCW. CHH involves the production of dilute acid, activated carbon, and carbon through a catalytic system inside a reactor, contributing to CO₂ emissions. The high ethanol yield from CHH also affected the fermentation process by releasing CO₂. Supercritical water requires substantial energy consumption to achieve the necessary state, resulting in higher emissions due to increased heating utilities.

Compared to enzymatic hydrolysis, the carbon footprint value is lower with 33 g CO₂/MJ [31] compared to SCW and scCO₂-H₂O with three to four times higher, respectively. For CHH, the carbon footprint

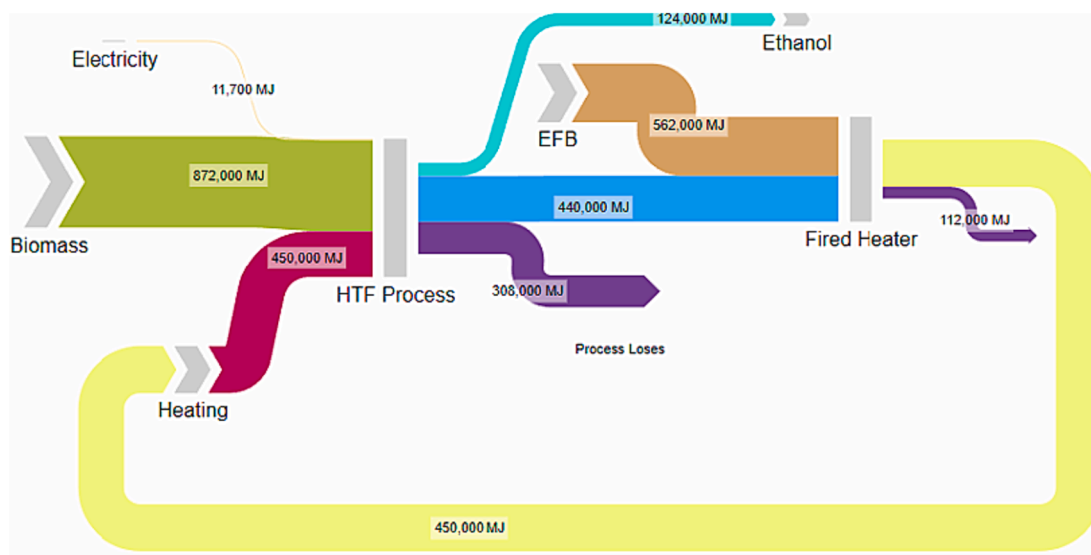

a

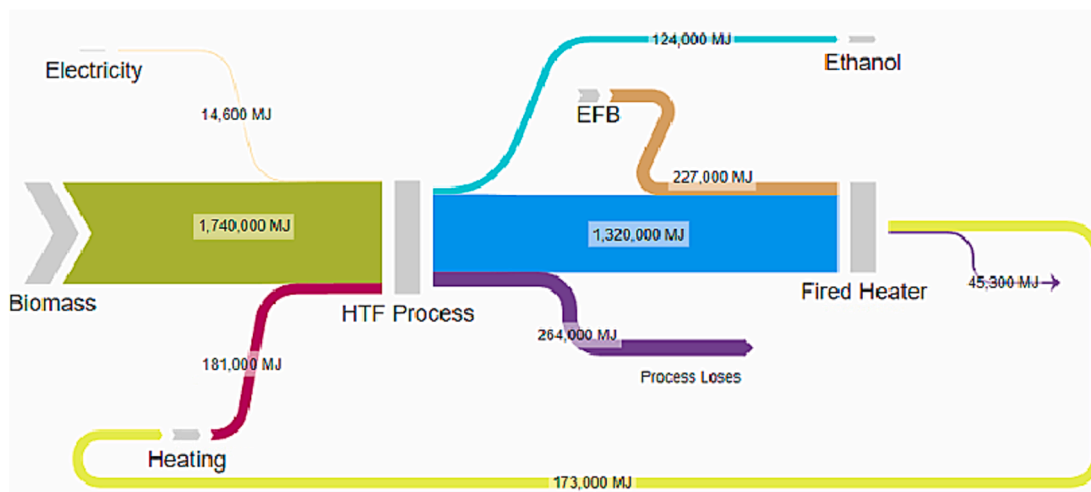

b

Fig. 4. Energy balance of cellulose degradation pathways (a. supercritical water, b. CO₂-water, c. catalytic hydrothermal hydrolysis).

differs by two times higher than enzymatic hydrolysis as illustrated in Fig. 5. The mild temperature used in enzymatic hydrolysis contributes to lower emissions, and the CO₂ gases produced can be used for enzyme harvesting.

Economic analysis

An economic analysis was undertaken to ascertain the production cost associated with lignocellulosic ethanol production reliant on the cellulose degradation pathway corresponding with the specified design parameters. The economic analysis for SCW, scCO₂-H₂O and CHH are benchmarked with enzymatic hydrolysis using corn stover as a basis for commercial lignocellulosic ethanol. For a fair economic comparison, CAPEX values enzymatic hydrolysis taken from Humbird et al. [11] were adjusted with chemical engineering plant cost index (CEPCI) of 2022 and normalised ethanol production capacity using the economy of scale

formulation in Eq. (8),

$$\frac{CAPEX_2}{CAPEX_1} = \left(\frac{Capacity_2}{Capacity_1} \right)^n \tag{8}$$

The CAPEX can be interpreted as investment cost, the *n* is exponential factor that depends on the type of plants. In general the value of *n* is 0.6 but for lignocellulosic bioethanol the value change to 0.7 [46].

The comprehensive investment expenditures were calculated employing the Guthrie method, which utilises bare modules for each equipment item that was simulated within Aspen Plus™. Given the bioethanol production capacity, enzyme has a lower capital investment with 158 USD million, equivalent to USD 3.16 per litre, similar with CHH that requires a capital investment of USD 160 million (USD 3.2 per litre), compared to USD 225 million (USD 5.11 per litre) for SCW and USD 214 million (USD 4.28 per litre) for scCO₂-H₂O. The 41 % and 33 %, the greater investment costs for SCW and scCO₂-H₂O arise from their

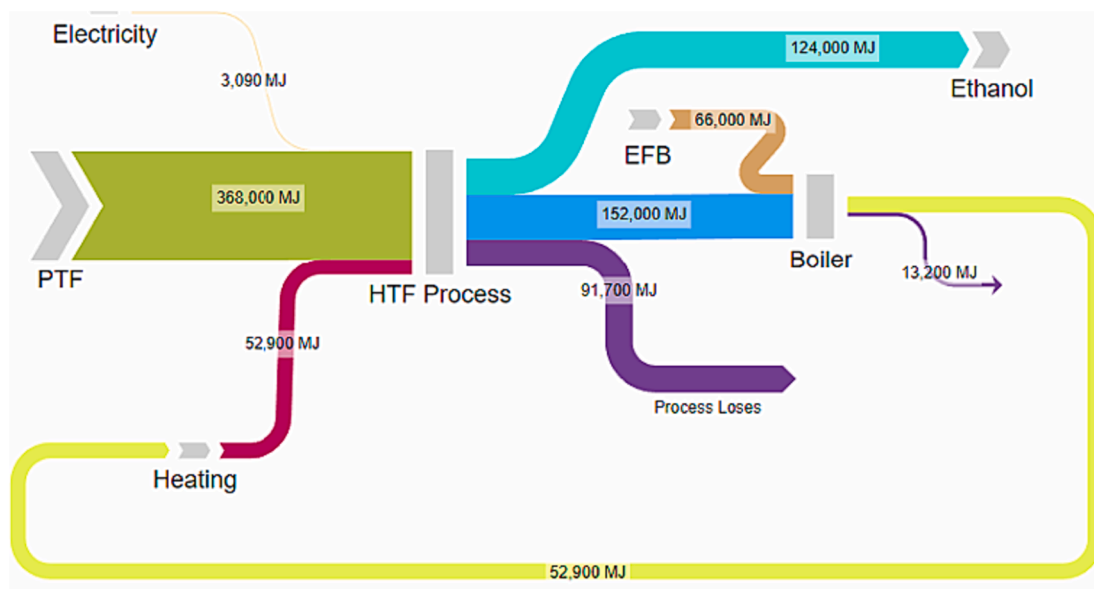

C

Fig. 4. (continued).

Table 3
Total carbon footprints for PTF per Ethanol produced.

Inventory	Carbon Footprint (g CO ₂ -eq/MJ Ethanol)
N-fertilizer	0.09
P-Fertilizer	0.53
K-Fertilizer	0.89
Urea	3.77
Kieserite	0.01
Dolomite	0.18
Pesticides/Herbicides	0.14
Diesel	1.15
Electricity	3.01
Methane (CH ₄)	21.09
Total	30.86

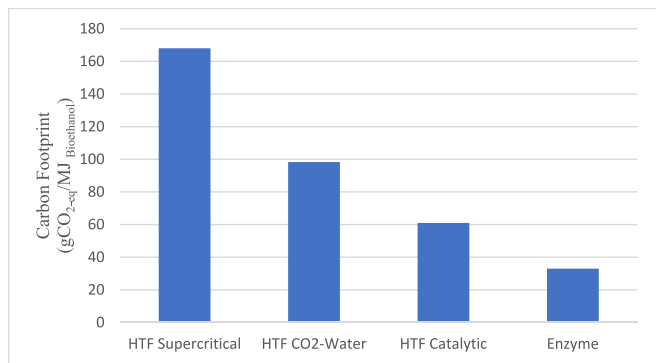

Fig. 5. GHG emissions by different hydrolysis.

larger purchased equipment cost resulting from higher operating conditions. Specifically, the additional high-pressure and high-temperature units contribute to increased total installed equipment costs compared to the milder enzymatic and CHH processes.

The comparison of bioethanol's production cost between enzymatic hydrolysis with SCW and scCO₂-H₂O and CHH presented in Fig. 6.

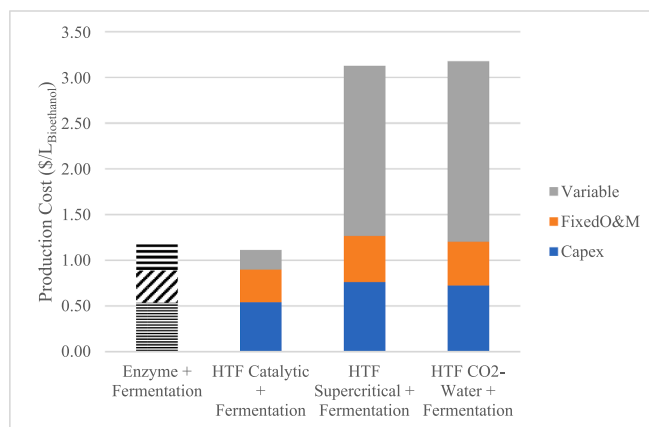

Fig. 6. Bioethanol production cost breakdown by different processes.

In contrast, scCO₂-H₂O exhibits the highest production cost among all the pathways at 3.18 \$/L versus 3.13 \$/L for SCW, 1.11 \$/L with CHH, and 1.17 \$/L for enzymatic hydrolysis. The reason is that the scCO₂-H₂O process had the lowest conversion of feedstock to ethanol, resulting in a variable cost of 1.97 \$/L, of which 60 % is accounted to the feedstock cost. Compared to scCO₂-H₂O, the production cost of SCW is lower by 2 % due to higher feedstock conversion efficiency to ethanol, resulting in a V.Cost of 1.86 \$/L. Overall, the production cost breakdown of lignocellulosic ethanol utilising SCW and scCO₂-H₂O exhibits substantial similarities to first-generation bioethanol rather than second-generation, with the V.Cost constituting the predominant share. In contrast, the production cost breakdown from CHH similar to advanced bioethanol, with CAPEX and F.O&M accounting for the most significant cost components [17].

The CHH process yields promising economic results that can compete with enzymatic hydrolysis. The slightly higher by 1 % capital cost for CHH arises from higher operating condition required for cellulose degradation, whereas enzymatic hydrolysis has a milder temperature. Conversely, CHH has a lower production cost of 1.11 \$/L versus 1.17 \$/L for enzymatic hydrolysis, by 5 % difference. This lower

production cost for CHH can be attributed in part to lower feedstock prices, with PTF costing only 11.7 \$/tonne [38] compared to 58 \$/tonne for corn stover used in enzymatic processing [11]. Therefore, while capital requirements are comparable, the operating cost benefits of CHH make it economically competitive with mature enzymatic approaches for bioethanol production. When applying the same raw material input, enzymatic hydrolysis shows lower PTF usage than CHH, owing to a 2 % yield from enzymatic hydrolysis. Furthermore, enzyme and activated carbon catalyst utilisation are impactful cost factors to *V.Cost*, with enzymes incurring 48 % of variable expenses observed by Liu et al. [24] over twice the 23 % fraction for AC catalysts in the CHH case study. Consequently, for identical feedstock consumption, CHH confers an economic edge regarding the catalyst costs pertinent to cellulose degradation.

Given these advantageous process economics for CHH, sensitivity analysis was performed to determine the impact of varying the estimated CAPEX of CHH process on ethanol production costs. The CAPEX was varied within a ± 10 –30 % range, which is considered reflective of the typical ± 30 % accuracy bounds for early cost estimations [27,41]. The CAPEX of CHH was selected as the variable for sensitivity testing due to its superior technical and economic performance over the previously analyses SCW and *scCO*₂-H₂O approaches.

The result in Fig. 7, found that incrementally reducing the CHH CAPEX estimate by -10 %, -20 % and -30 % led to stepwise decreases in production costs of 5.7 %, 11.6 % and 17.8 %, respectively, lowering the initial 1.11 \$/L base case estimate progressively to 1.05 \$/L, 0.98 \$/L and 0.91 \$/L. On the other hand, incrementally elevating the CAPEX by $+10$ %, $+20$ % and $+30$ % resulted in gradual production cost increases of 5.6 %, 11 % and 16.3 %, raising the base case sequentially to 1.18 \$/L, 1.24 \$/L and 1.29 \$/L. Notably, at -30 %, -20 % and -10 % CAPEX values, the CHH production costs were 22 %, 16 % and 10 % less than the benchmark enzymatic process. Even at $+10$ % CAPEX, CHH has the same production cost with enzymatic process. However, at $+20$ % and $+30$ % CAPEX, the CHH costs exceeded enzymatic processing by 6 % and 11 %, respectively. The analysis showed that even when CAPEX was increased substantially by 20–30 %, the CHH production cost remained within 6–11 % of that for enzymatic hydrolysis. This demonstrates the economic viability of CHH as a novel, non-conventional technology option for lignocellulosic ethanol production.

Conclusion

Techno-enviro-economic of thermochemical conversion routes using three pathways are performed. CHH has emerged as the most favourable pathway for second-generation bioethanol production, providing a high ethanol yield, lower production costs, and environmental performance. A comparison between the CHH and enzymatic hydrolysis revealed the lowest production cost with 0.06 \$/L difference due to the lower variable cost (*V.Cost*). CHH presents a 1 % higher CAPEX than enzymatic hydrolysis, primarily because of higher operating condition subsequent equipment costs. While enzymatic hydrolysis has 25 % higher variable cost than CHH because of the feedstock cost. Additionally, regarding the environmental impact, enzymatic hydrolysis is more sustainable, with approximately 50 % lower emissions than CHH. The lower investment cost, higher ethanol yield, and reduced ecological footprint have contributed to its widespread industrial utilisation. CHH can be a viable option for bioethanol production due to its lower production cost. Nevertheless, it is imperative to consider the increased conversion from CHH and the environmental consequences associated with this approach. To address this issue, derivatisation from hydrolysis to produce activated carbon could substantially reduce the carbon footprint associated with CHH. Therefore, further investigation is required to explore the feasibility of this strategy and identify additional measures to reduce the environmental impact of CHH.

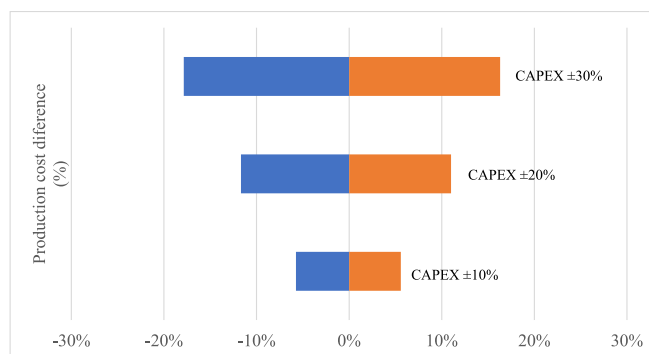

Fig. 7. Sensitivity analysis production cost of CHH by different CAPEX.

CRedit authorship contribution statement

Hasbi Priadi: Conceptualization, Project administration, Resources, Software, Writing – original draft, Writing – review & editing. **Sary Awad:** Conceptualization, Supervision, Validation, Visualization. **Audrey Villot:** Conceptualization, Supervision, Validation, Visualization. **Yves Andres:** Conceptualization, Formal analysis, Investigation, Supervision, Validation, Visualization. **Widodo Wahyu Purwanto:** Conceptualization, Resources, Formal analysis, Investigation, Supervision, Validation, Visualization.

Declaration of competing interest

The authors declare that they have no known competing financial interests or personal relationships that could have appeared to influence the work reported in this paper.

Data availability

Data will be made available on request.

Appendix A. Supplementary data

Supplementary data to this article can be found online at <https://doi.org/10.1016/j.ecmx.2023.100522>.

References

- [1] Anastasia Kharina CM. and Stephanie Searle. Overview and Current Status. International Council Cleaner Transportation: Biofuels Policy in Indonesia; 2016.
- [2] Banerjee S, Mudliar S, Sen R, Giri B, Satpute D, Chakrabarti T, et al. Commercializing lignocellulosic bioethanol: technology bottlenecks and possible remedies. *Biofuels Bioprod Biorefin* 2010;4(1):77–93.
- [3] Bhavana Banuvalli SM, Vijay S, Bokade, Debnath. Evaluation of inhibition kinetics of furfural, 5-hydroxymethylfurfural and acetic acid on xylitol fermentation by *Pichia stipitis*. *Authorea* 2022.
- [4] Brunner G. Near critical and supercritical water. Part I. Hydrolytic and hydrothermal processes. *J Supercrit Fluids* 2009;47(3):373–81.
- [5] Cocero MJ, Cabeza Á, Abad N, Adamovic T, Vaquerizo L, Martínez CM, et al. Understanding biomass fractionation in subcritical & supercritical water. *J Supercrit Fluids* 2018;133:550–65.
- [6] Didier Bourguignon TV. Advanced biofuels Technologies and EU policy. *EPRS* 2017.
- [7] Gírio FM, Fonseca C, Carvalheiro F, Duarte LC, Marques S, Bogel-Lukaszik R. Hemicelluloses for fuel ethanol: A review. *Bioresour Technol* 2010;101(13):4775–800.
- [8] Gorenske MB, Shukre R, Chen C-C. Development of a thermophysical properties model for flowsheet simulation of biomass pyrolysis processes. *ACS Sustain Chem Eng* 2019;7(9):9017–27.
- [9] Hammond DA, Karel M, Klibanov AM, Krukoni VJ. Enzymatic reactions in supercritical gases. *Appl Biochem Biotechnol* 1985;11(5):393–400.
- [10] Hsiao YW, Anastasopoulou A, Ierapetritou M, Vlachos DG. Cost and energy efficient cyclic separation of 5-hydroxymethyl furfural from an aqueous solution. *Green Chem* 2021;23(11):4008–23.
- [11] D. Humbird R. Davis L. Tao C. Kinchin D. Hsu A. Aden et al. Process design and economics for biochemical conversion of lignocellulosic biomass to ethanol: dilute-

- acid pretreatment and enzymatic hydrolysis of corn stover. National Renewable Energy Lab (NREL), 2011 Golden, CO (United States).
- [12] IEA. 2022. CO2 Emissions in 2022. International Energy Agency.
- [13] IEA. 2021. Renewables 2021. International Energy Agency.
- [14] Iea Sustainable Production of Second-Generation Biofuels IEA. 2010.
- [15] Irena. Bioenergy for the energy transition: Ensuring sustainability and overcoming barriers. International Renewable Energy Agency; 2022.
- [16] Irena. Production of Liquid Biofuels. Technology Brief; 2013.
- [17] Irena Road Transport: The Cost of Renewable Solutions 2013.
- [18] Irena. Scaling up biomass for the energy transition: Untapped opportunities in Southeast Asia. Int Renewable Energy Agency 2022.
- [19] Iscc. ISCC EU 205 Greenhouse Gas Emissions. International Sustainability and Carbon Certification (ISCC); 2021.
- [20] Jenkins S. 2022 CEPCI Updates. Chemical Engineering Online; 2022. December 2022 ed.
- [21] Khongchamnan P, Suriyachai N, Kreetachai T, Laosiripojana N, Weerasai K, Champreda V, et al. Optimization of liquid hot water pretreatment and fermentation for ethanol production from sugarcane bagasse using *saccharomyces cerevisiae*. *Catalysts* 2022.
- [22] Kim KH, Hong J. Supercritical CO₂ pretreatment of lignocellulose enhances enzymatic cellulose hydrolysis. *Bioresour Technol* 2001;77(2):139–44.
- [23] Kobayashi H, Yabushita M, Komanoya T, Hara K, Fujita I, Fukuoka A. High-yielding one-pot synthesis of glucose from cellulose using simple activated carbons and trace hydrochloric acid. *ACS Catal* 2013;3(4):581–7.
- [24] Liu G, Zhang J, Bao J. Cost evaluation of cellulase enzyme for industrial-scale cellulosic ethanol production based on rigorous Aspen Plus modeling. In: *Bioprocess and Biosystems Engineering*; 2016. p. 39.
- [25] Long J, Guo B, Li X, Jiang Y, Wang F, Tsang SC, et al. One step catalytic conversion of cellulose to sustainable chemicals utilizing cooperative ionic liquid pairs. *Green Chem* 2011;13(9):2334–8.
- [26] Macrelli S, Mogensen J, Zacchi G. Techno-economic evaluation of 2nd generation bioethanol production from sugar cane bagasse and leaves integrated with the sugar-based ethanol process. *Biotechnol Biofuels* 2012;5(1):22.
- [27] M.S. Peters K.D.T., Ronald E. Wes. *Plant design and economics for chemical engineers* 5 ed. 2002 McGraw-Hill Professional New York, NY.
- [28] Morais ARC, Mata AC, Bogel-Lukasik R. Integrated conversion of agroindustrial residue with high pressure CO₂ within the biorefinery concept. *Green Chem* 2014; 16(9):4312–22.
- [29] Morales M, Quintero J, Conejeros R, Aroca G. Life cycle assessment of lignocellulosic bioethanol: environmental impacts and energy balance. *Renew Sustain Energy Rev* 2015;42:1349–61.
- [30] A.W. Nugroho *Life Cycle Assessment (LCA) Industri Pengolahan Crude Palm Oil (CPO) (Studi Kasus di PTPN V (Persero) 2014 Provinsi Riau)*.
- [31] Olofsson J, Barta Z, Börjesson P, Wallberg O. Integrating enzyme fermentation in lignocellulosic ethanol production: life-cycle assessment and techno-economic analysis. *Biotechnol Biofuels* 2017;10(1):51.
- [32] Peng J, Xu H, Wang W, Kong Y, Su Z, Li B. Techno-economic analysis of bioethanol preparation process via deep eutectic solvent pretreatment. *Ind Crop Prod* 2021; 172:114036.
- [33] Pereira FB, Romaní A, Ruiz HA, Teixeira JA, Domingues L. Industrial robust yeast isolates with great potential for fermentation of lignocellulosic biomass. *Bioresour Technol* 2014;161:192–9.
- [34] Peter van Walsum G, Shi H. Carbonic acid enhancement of hydrolysis in aqueous pretreatment of corn stover. *Bioresour Technol* 2004;93(3):217–26.
- [35] Priadi H, Awad S, Purwanto WW, Andres Y. Mapping the potential of palm oil by product for second generation bio-ethanol. *AIP Conf Proc* 2020;2255(1).
- [36] Quintero JA, Moncada J, Cardona CA. Techno-economic analysis of bioethanol production from lignocellulosic residues in Colombia: a process simulation approach. *Bioresour Technol* 2013;139:300–7.
- [37] RSPO. 2012. A Greenhouse Gas Accounting Tool for Palm Products. Roundtable of Sustainable Palm Oil (RSPO).
- [38] Saharudin DM, Jeswani HK, Azapagic A. Bioenergy with carbon capture and storage (BECCS): Life cycle environmental and economic assessment of electricity generated from palm oil wastes. *Appl Energy* 2023;349:121506.
- [39] Saka S, Miyafuji H. Bioethanol Production from Lignocellulosics Using Supercritical Water. In: *Materials, Chemicals, and Energy from Forest Biomass*, Vol. 954. American Chemical Society; 2007. p. 422–33.
- [40] Schacht C, Zetzl C, Brunner G. From plant materials to ethanol by means of supercritical fluid technology. *J Supercrit Fluids* 2008;46(3):299–321.
- [41] Seider WD, Seader JD, Lewin DR, Widagdo S. *Product and Process Design Principles: Synthesis, Analysis and Design*: Wiley; 2016.
- [42] Serna-Loaiza S, Zikeli F, Adamczyk J, Friedl A. Towards a wheat straw biorefinery: Combination of Organosolv and Liquid Hot Water for the improved production of sugars from hemicellulose and lignin hydrolysis. *Bioresour Technol* 2021;14:100667.
- [43] Shabani MR, Yekta RB. Suitable method for capital cost estimation in chemical processes industries. *Cost Eng (morgantown, West Virginia)* 2006;48:22–5.
- [44] Shrotri A, Kobayashi H, Fukuoka A. Efficient catalytic conversion of cellulose to platform chemicals using mechanical treatment. *J Jpn Pet Inst* 2015;58(1):1–8.
- [45] Sun Y, Cheng J. Hydrolysis of lignocellulosic materials for ethanol production: a review. *Bioresour Technol* 2002;83(1):1–11.
- [46] Tsagkari M, Couturier J-L, Kokossis A, Dubois J-L. Early-stage capital cost estimation of biorefinery processes: a comparative study of heuristic techniques. *ChemSusChem* 2016;9(17):2284–97.
- [47] Wang T, Meng Y, Qin Y, Feng W, Wang C. Removal of furfural and HMF from monosaccharides by nanofiltration and reverse osmosis membranes. *J Energy Inst* 2018;91(3):473–80.
- [48] Wang Y, Song H, Peng L, Zhang Q, Yao S. Recent developments in the catalytic conversion of cellulose. *Biotechnol Biotechnol Equip* 2014;28(6):981–8.
- [49] Yusof SJHM, Roslan AM, Zakaria MR, Hassan MA, Shirai Y. Kinetics of xylan autohydrolysis during subcritical hydrothermal pretreatment of oil palm frond pressed fiber. *Bioenergy Res* 2022;15(1):439–53.
- [50] Zhao L, Zhang X, Xu J, Ou X, Chang S, Wu M. Techno-economic analysis of bioethanol production from lignocellulosic biomass in china: dilute-acid pretreatment and enzymatic hydrolysis of corn stover. *Energies* 2015;8(5): 4096–117.
- [51] Zhao Y, Lu W-J, Wang H-T. Supercritical hydrolysis of cellulose for oligosaccharide production in combined technology. *Chem Eng J* 2009;150(2):411–7.
- [52] Zhao Y, Wang H, Lu W, Li D. Supercritical/subcritical technology for pretreatment and hydrolyzation of stalks. *Prog Chem* 2007;19(11):1832.